



**OSP ASCEND II™** Height Adjustable

*Supporting active working for a healthier lifestyle*



Moving improves circulation, which delivers more oxygen to the brain, which increases energy and attentiveness. You think more. You do more. You need less coffee ... but you can still enjoy it.



New modesty panels with drop-down design allow attachment of accessories and routing wires out of sight.



Shown with  
Napa White Credenza,  
Pedestal & Glass Door Hutch



- A322460BW** 3-Stage, Dual-Motor 60"x24"  
Height Adjustable, Black Base/White Top  
**\$1,940**
- A2MOD60-WHT** 60" Modesty Panel, White  
**\$250**
- A2PS-B** Locking Storage Drawer/Shelf, Black  
**\$275**
- A2MAS1730-B** Single Monitor Arm, Black  
**\$275**
- PM5311B** Power/USB Charger, Black  
**\$275**

3-stage, dual-motor bases make quick work of adjusting work height between 24.75" and 50.25"







Shown with Napa casegoods,  
Metal File & SPACE SEATING®

**A2MAD1730-BK**  
Double Monitor Arm  
Black **\$525**

**A337272SVS** 72"x72 3-Stage/3-Motor L-Shape  
Slate Grey Tops/Silver Base **\$3,270**

## DELUXE C-LEG BASES

Fast • Quiet • Width Adjustable

Base (without top)	Height Range	Load Capacity	High/Low Position
A2EB322	25.25"	220 lbs.	50" / 24.75"
A2EB333	25.5"	300 lbs.	50.25" / 24.75"
A2EB222	17.25"	175 lbs.	44.75" / 27.5"

### 4-Position Memory Handset

Program any 4 positions

One-Touch memory

Set min. and  
max heights

Set hi and lo  
lockout heights

Anti-collision protection

Overload protection



## Tops

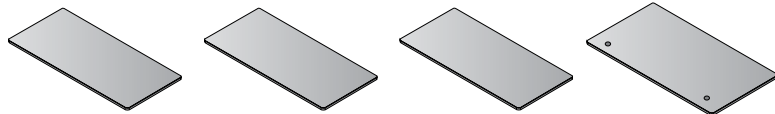

**842T26-X**  
Table Top 72"x24"  
CU: 1.9 WT: 44  
List: **\$440**

**842T25-x**  
Table Top 60"x24"  
CU:1.6 WT:36  
List: **\$390**

**842T24-x**  
Table Top 48"x24"  
CU:1.3 WT:28  
List: **\$330**

**842T3060-x**  
Table Top 60"x30"  
CU: 2.5 WT: 50.7  
List: **\$460**

## Top Colors



## Bases

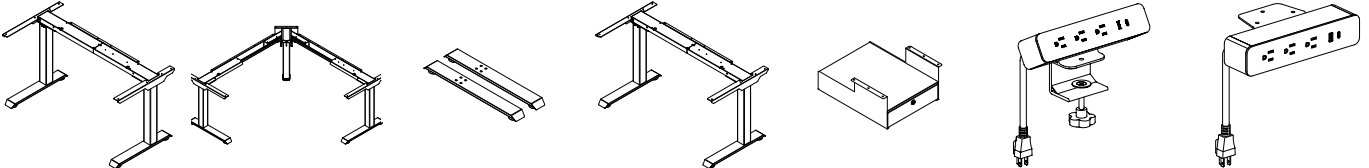

**A2EB322-xx**  
3-Stage/2-Leg  
CU:2.8 WT:64  
List: **\$1,550**

**A2EB333-xx**  
3-Stage/3-Leg  
CU:2.9 WT:94  
List: **\$2,500**

**A2FEET30-x**  
Feet for 30"D Tops  
(set of 2)  
CU:0.27 WT:12  
List: **\$175**

**A2EB222-x**  
2-Stage/2-Leg  
CU:2.8 WT:59  
List: **\$1,500**

**A2PS-x**  
Personal Storage  
15.5"W x 18"D x 7.5"H  
CU:1.49 WT:34  
List: **\$275**

**PM5311B Black**  
**PM5311W White**  
Power Charger  
Clamp-Mount  
Includes: USB Type-C,  
USB Type-A and  
(3) A/C plugs  
Fits 1/2" - 1 1/2" surfaces  
CU:0.22 WT:3  
List: **\$290**

**PM8311B Black**  
**PM8311W White**  
Power Charger  
Undersurface Mount  
Includes: USB Type-C,  
USB Type-A and  
(3) A/C plugs  
CU:0.22 WT:3  
List: **\$290**

## Base Colors



## Modesty Panels

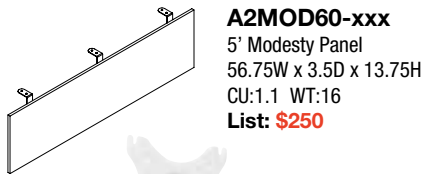

**A2MOD60-xxx**  
5' Modesty Panel  
56.75W x 3.5D x 13.75H  
CU:1.1 WT:16  
List: **\$250**

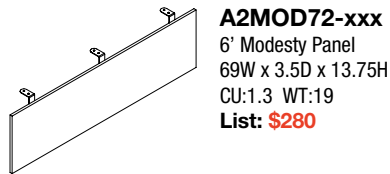

**A2MOD72-xxx**  
6' Modesty Panel  
69W x 3.5D x 13.75H  
CU:1.3 WT:19  
List: **\$280**

## Modesty Colors

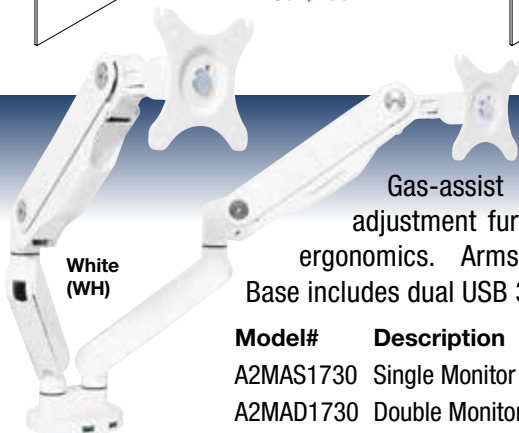

## Monitor Arms

Gas-assist Monitor Arms with 3-point adjustment further individualize workplace ergonomics. Arms support 17"-30" monitors. Base includes dual USB 3.0 ports within easy reach.

Model#	Description	List:
A2MAS1730	Single Monitor Arm with Dual USB 3.0 Ports	<b>\$275</b>
A2MAD1730	Double Monitor Arm with Dual USB 3.0 Ports	<b>\$525</b>

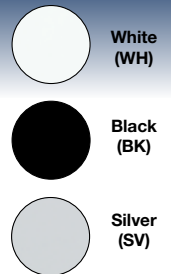

### A322460BW

3-Stage 60"x24" Height Adjustable **\$1,940**

Consists of:

**A2EB322-B** 3-Stage, Dual-Motor Base, Black  
**842T25-W** 60"x24" Top, White

Accessories:  
A2MOD60-WHT  
A2PS-B  
PM5311B  
A2MAS1730-BK

Casegoods:  
NAP-43-WHT  
NAP-65-WHT  
NAPWHT-42

# OSP ASCEND II™ WORKSTATIONS

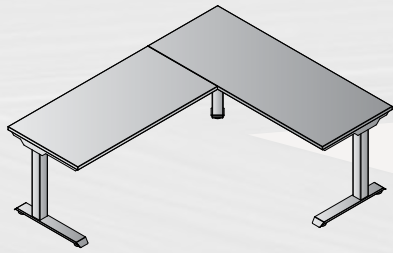

## A336072

60" x 72" x 51-25.5"H  
 Electric Height Adjustable L-Shape  
 CU: 5.8 (3 cartons) WT.: 158  
**List: \$3,220**

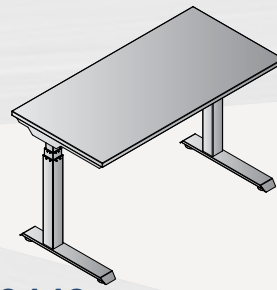

## A322448

48" x 24" x 51-25.5"H  
 Electric Height Adjustable Table  
 CU: 4.1 (2 cartons) WT.: 92  
**List: \$1,880**

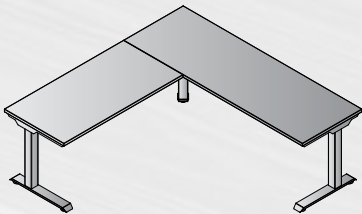

## A337272

72" x 72" x 51-25.5"H  
 Electric Height Adjustable L-Shape  
 CU: 6.1 (3 cartons) WT.: 164  
**List: \$3,270**

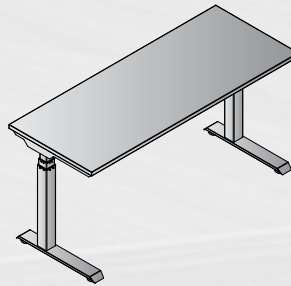

## A322460

60" x 24" x 51-25.5"H  
 Electric Height Adjustable Table  
 CU: 4.4 (2 cartons) WT.: 100  
**List: \$1,940**

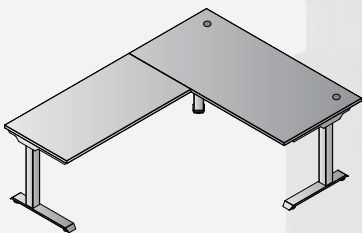

## A336078

59" x 77.25" x 51-25.5"H  
 Electric Height Adjustable L-Shape  
 CU: 6.7 (3 cartons) WT.: 172.7  
**List: \$3,290**

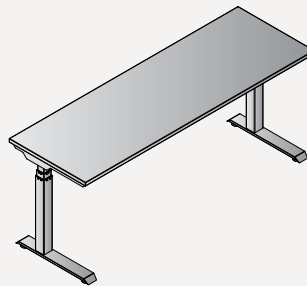

## A322472

72" x 24" x 51-25.5"H  
 Electric Height Adjustable Table  
 CU: 4.7 (2 cartons) WT.: 108  
**List: \$1,990**



## A323060

59" x 30" x 51-25.5"H  
 Electric Height Adjustable Table  
 CU: 5.3 (2 cartons) WT.: 114.7  
**List: \$2,010**

*Our bodies  
 were born  
 to move.  
 Alternate  
 between  
 standing  
 and sitting  
 throughout  
 the day  
 to avoid  
 sedentary  
 effects and to  
 allow proper  
 alignment  
 of your  
 shoulders,  
 neck and  
 back.*





**A2MAS1730** Single Monitor Arm **\$275**

# MONITOR ARMS

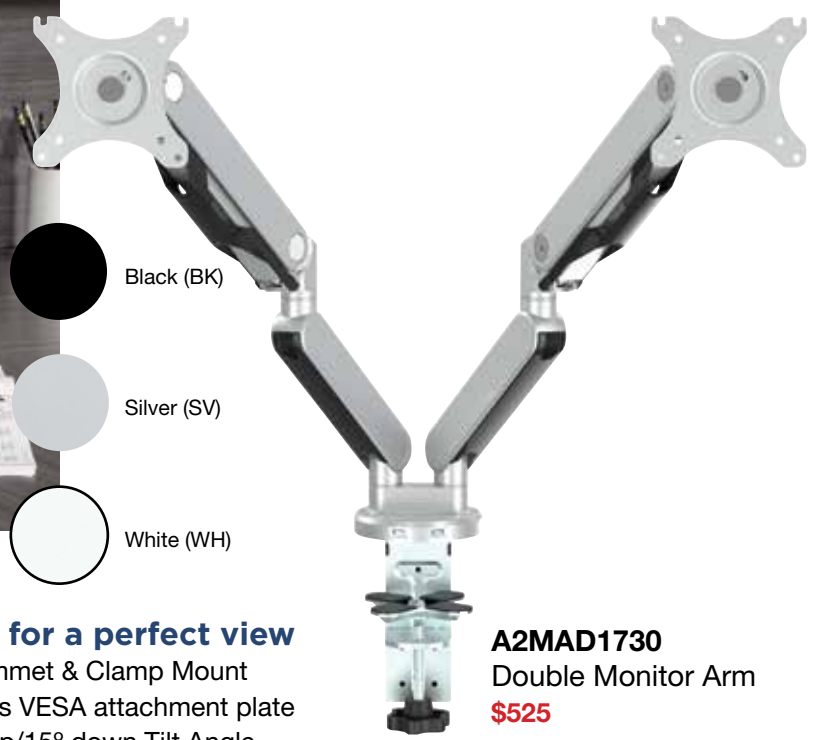

**A2MAD1730**  
Double Monitor Arm  
**\$525**

-  Black (BK)
-  Silver (SV)
-  White (WH)

## Gas-assist, 3-point pivot Monitor Arms for a perfect view

Dual USB 3.0 ports • Cable Management • Grommet & Clamp Mount  
Supports 17"-30" monitors up to 20 lbs. and includes VESA attachment plate  
Pivots: 135° Base / 180° Center / 90° Top • 85° up/15° down Tilt Angle

# POWER CHARGERS



**PM5311B | PM5311W** Clamp Mount **\$290**



**PM8311B | PM8311W** Undersurface Mount **\$290**

## Convenient, worksurface-height power & charging

USB Type C port + USB Type A port + (3) A/C Outlets  
Color-Matched ABS & Aluminum Materials • 6' Power Cord • UL Listed



## OSP ASCEND II™

features full-function, commercial-quality height-adjustable C-Leg bases with UL Listed parts and meeting ANSI/BIFMA standards. Best-choice 3-stage frames (dual-motor and triple-motor L shape) are width-adjustable with optimum height range, load capacity, speed and sound characteristics.







# MOBILE PEDESTALS



Mobile Box/File Ped  
Black Fabric Cushion (Magnetic Attachment)

**BXPMC22BF** Silver (-SV), White (-WH)

**\$560**

Also available without cushion:

**PM22BF** Silver (-SV), White (-WH)

**\$400**



Mobile Box/Box/File Ped **PTC22BBF**

Mobile File/File Ped **PTC22FF**

Silver (-SV), White (-WH), Black (-B)

**\$525**



## Personal Storage

Drawer with Lock + Shelf Area

Installs under worksurface

Clearance for

OSP Ascend II™ Bases

**A2PS**

Silver (-SV), White (-WH), Black (-B)

**\$275**





Standing burns more calories than sitting. So you can find comfort standing up as well as sitting in a comfortable chair. We have several of those, too.

*Shown with Napa White Credenza, Pedestal & Glass Door Hutch*

- A337272WHU** 3-Stage, Triple-Motor 72"x72" L-Shape Height Adjustable Workstation with Urban Walnut Tops & White Base **\$3,270**
- A2MOD72-URB** 72" Modesty Panel, Urban Walnut **\$280**

- A2MAS1730-WH** Single Monitor Arm, White **\$275**
- PM5311W** Power/USB Charger, White **\$290**

## STANDING MAT

**AM2030B** 30" x 20" Standing Mat **\$75**

- Dense Memory Foam, 7/8" Thick
- Non-Slip
- Puncture-Resistant
- Stain-Resistant
- Non-Toxic, VOC-Free
- Relieves Stress on Feet & Joints

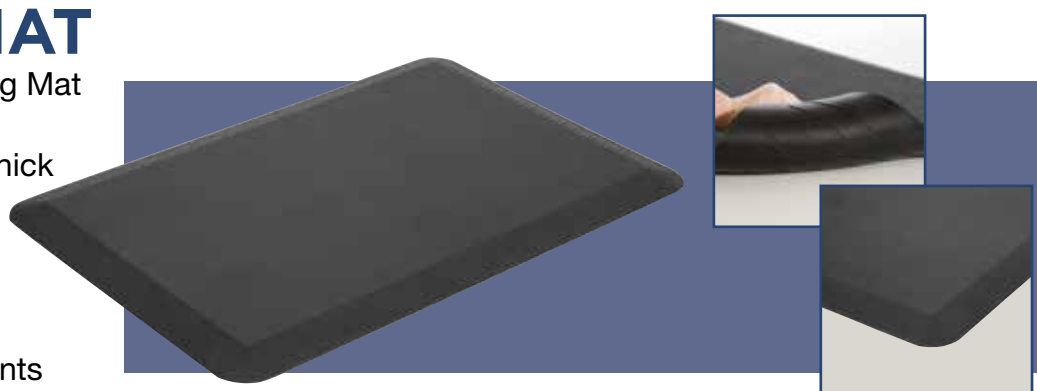

# ADDITIONAL WORKSURFACES

## Rectangular Worksurfaces



PWS7230\_\_\_ 72"x 30"

PWS6630\_\_\_ 66"x 30"

PWS6030\_\_\_ 60"x 30"

PWS4830\_\_\_ 48"x 30"

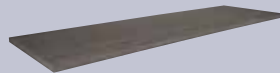

PWS7224\_\_\_ 72"x 24"

PWS6624\_\_\_ 66"x 24"

PWS6024\_\_\_ 60"x 24"

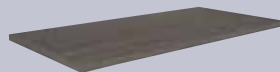

PWS4824\_\_\_ 48"x 24"

PWS4224\_\_\_ 42"x 24"

PWS3624\_\_\_ 36"x 24"

PWS3024\_\_\_ 30"x 24"

PWS2424\_\_\_ 24"x 24"

## Corner and Bullet Worksurfaces



PWS36CNR\_\_\_ 36"x 36"  
Corner

PWS42CNR\_\_\_ 42"x 42"  
Corner

PWS7230BU\_\_\_ 72"x 30"  
Bullet

## COLOR OPTIONS

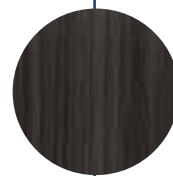

**SGW**  
Slate Grey

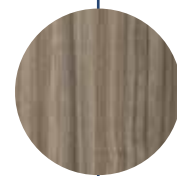

**URB**  
Urban Walnut

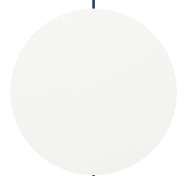

**WHT**  
White

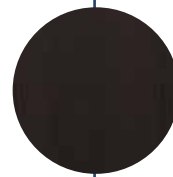

**ESP**  
Espresso  
NJ Only



**NAS**  
Natty Ash



**PCW**  
Park City  
NJ Only



Urban Walnut Top & Modesty Panel shown with Black (B) and Silver (SV) bases





## Sit. Stand. Repeat.

Our bodies were born to move. Adjust your position throughout the day to help your body and mind perform their best.



P.O. Box 3520, Ontario, CA 91761  
p: 909.930.2000 | f: 909.930.5346  
www.officestar.net  
sales@officestar.net • orders@officestar.net  
© Office Star® Products January 2025